

B5 BR Mk1 CORRIDOR THIRD/later SECOND (TK/SK) D146/147/150

D146: 1776 built 1950-1964; withdrawn 1964-1991; 106 preserved 64'6"

D147: 386 built 1953-1963; withdrawn 1966-1992; 17 preserved

D150: 3 built 1958; withdrawn 1974/77/84; none preserved

These etched sides can be built into a complete coach using products from our range as supplied in our full kits; please refer to the panel opposite. They can also be used as a basis for a scratchbuilt coach, or to overlay a suitable RTR model.

These three diagrams together formed the largest group of BR Mk1 carriages. A side corridor gives access to eight compartments, divided into two groups by a central transverse vestibule with doors both sides. End doors were also provided. D146 had six seats per compartment with retractable armrests; D147 compartments had eight seats. D150 was effectively D146, but fitted with Metro-Schlieren bogies. All three diagrams have two toilets at one end, and a non-smoking compartment either side of the central vestibule.

Running numbers and original regional allocations

D146

M	24000-149, 24397-446, 24576-90, 24676-90, 24819-918, 25248-79, 25283-454, 25558-695 25704-73, 25973-26011, 26035-38
E	24150-63, 24180-279, 24447-538, 24549-56, 24569-75, 24591-650, 24691-700, 24754-90 24796-815, 24945-5044, 25458-5507, 25774-860, 26138-217
W	24164-8, 24328-93
S	24169, 24302-27
Sc	24170-9, 24280-301, 24394-6, 24557-68, 24651-75, 24721-45, 24791-95, 24816-18, 24919-44 25696-703, 25861-905, 26012-59

D147 24539-48, 24701-20, 24746-53, 25045-247, 25906-72, 26060-137 (all WR)

D150 25280-2 (all LMR)

D146 from 25704 onwards were fitted with Commonwealth bogies from new as were D147 from 25906 onwards.

Livery

From inception to 1956 gangwayed passenger stock and most passenger full brakes were painted carmine and cream, with gold and black lining. The cream panel was the full height of the windows plus an inch top and bottom. The black line was against the cream. From 1956 to 1964 most coach types were painted maroon with gangwayed stock lined gold/black/gold at the waist and black/gold above the windows. This later livery saw the introduction of a new circular crest, which appeared with increasing frequency from around 1959. From 1965 onwards, where spray painting of the coaches was done, the ends were painted body colour to avoid the need for masking. Also from 1965 the new 'corporate image' livery of blue and grey was introduced. The grey was not carried to the end of the coach and there was a white line between it and the blue. Lettering and insignia were white. With the introduction of sectors, coaches appeared in many new liveries, too many to describe here.

Underframe building tips

1. The stepboards are best fitted after the solebars are soldered to the chassis but before the headstocks are soldered on and the central trussing is folded down. Use thin card to pack the stepboards up from the bottom of the solebar.
2. Solder a piece of scrap brass above the vacuum cylinder, spanning from the side to the centre strip. This gives a flat surface to solder the cylinder to.
3. The inner and outer frames of the regulator box cradle should be parallel. To fit the regulator box, place the underframe upside down and hold the box in place using a small flat file whilst fixing it in position.
4. Fit the dynamo by wedging the inner edge of the base in the angle formed by the upper and lower members of the centre trussing.

COMET MODELS components required to complete this carriage are:

Underframe	UB1	Bogies	BB1 or BB2
Underframe castings	UCB1	Interior	INT1
Ends	EB1	End castings	ECB1
Roof	C10	Roof castings	RC3

5. Leave a length of sprue attached to each direct admission valve which will span the centre truss from top to bottom. Hold the valve in position with a small flat file whilst fixing, and trim away the excess sprue afterwards.

Further information

British Railways Mk1 Coaches (and Supplement)	Keith Parkin	HMRS
BR Mark 1 & Mark 2 Coaching Stock	Hugh Longworth	OPC

Scrap views showing additional detailing of sides and ends
(not all details may apply to this diagram)

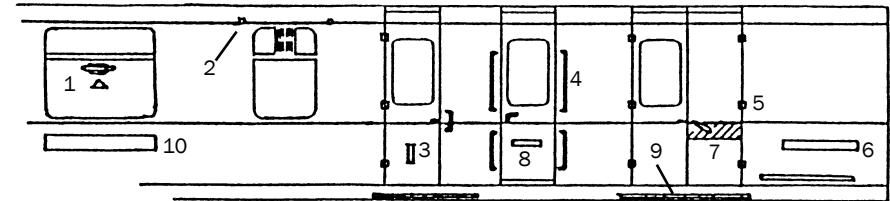

1. Window insignia (Firsts and No Smoking. In RH quarterlights of non-gangwayed stock)
2. Destination board bracket
3. Door insignia (First only and only on passenger doors)
4. Grab handles
5. Door hinges
6. Number (RH end 6" below waistline)
7. Slate grey panel on luggage doors
8. Door insignia (Guard and Kitchen on non-passenger doors)
9. Stepboards
10. Vehicle description, e.g. Kitchen Car (6" below waistline and central on side)

End A

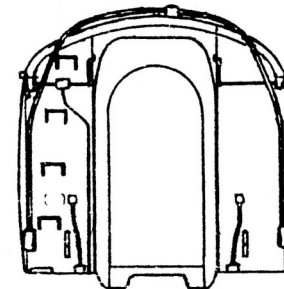

End B

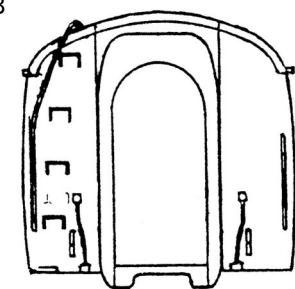

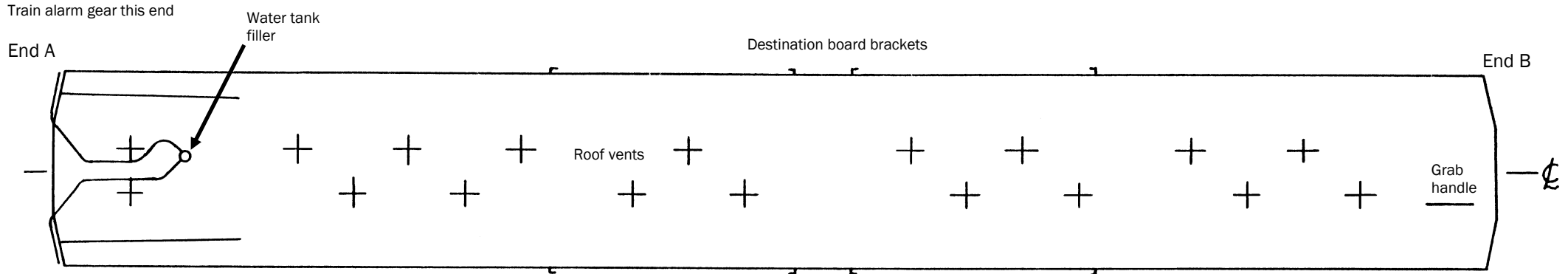

**ROOF AND INTERIOR PLANS
VIEWED FROM ABOVE**

Cut the interior floor at the dotted line both ends to clear the angled body fixing plate

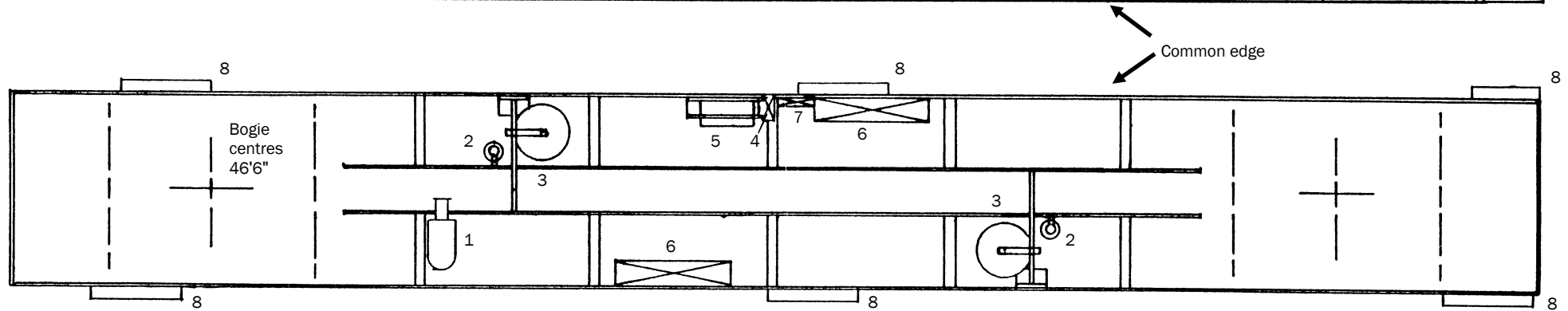
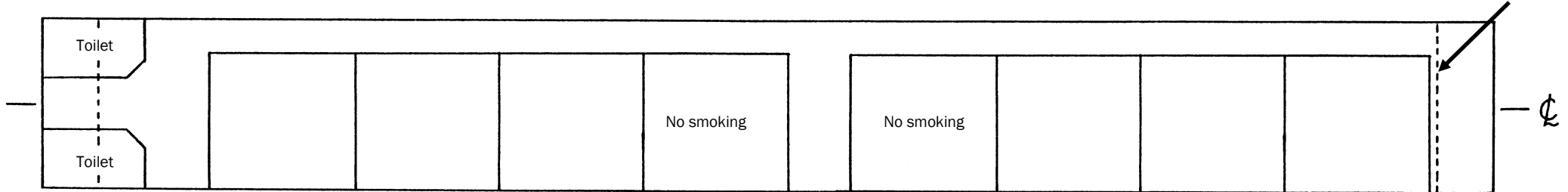

**UNDERFRAME VIEWED
FROM BELOW**

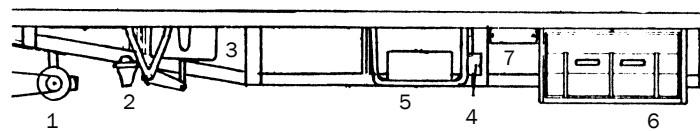

- 1. Dynamo
- 2. Direct admission valve
- 3. Vacuum cylinder
- 4. Lamp resistance box
- 5. Regulator
- 6. Battery box
- 7. Distribution fuse box
- 8. Stepboard